

REACTOR™

311299D

Hydraulic, Heated, Plural Component Proportioner
For spraying polyurethane foam and polyurea coatings.
Not for use in explosive atmospheres.



Important Safety Instructions

Read all warnings and instructions in this manual.
Save these instructions.

See page 3 for model information, including maximum working pressure.

Model H-25 with 8 kW Heater

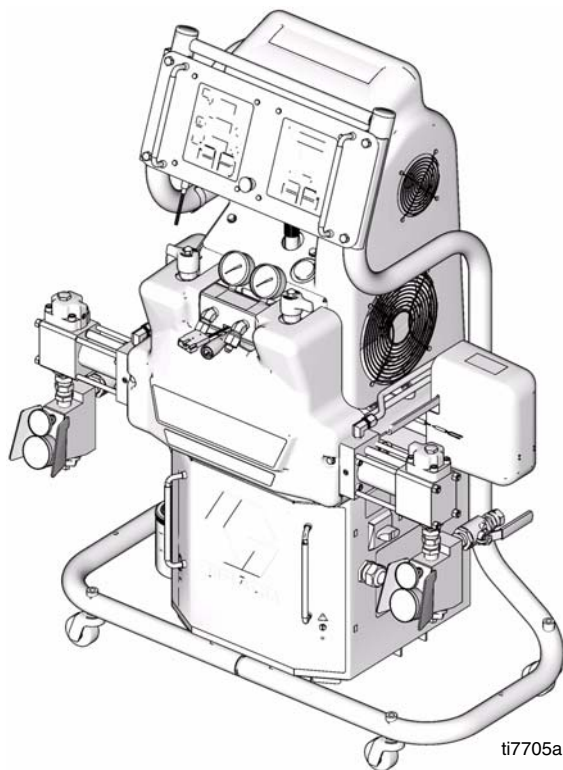

Model H-XP2 with 15.3 kW Heater

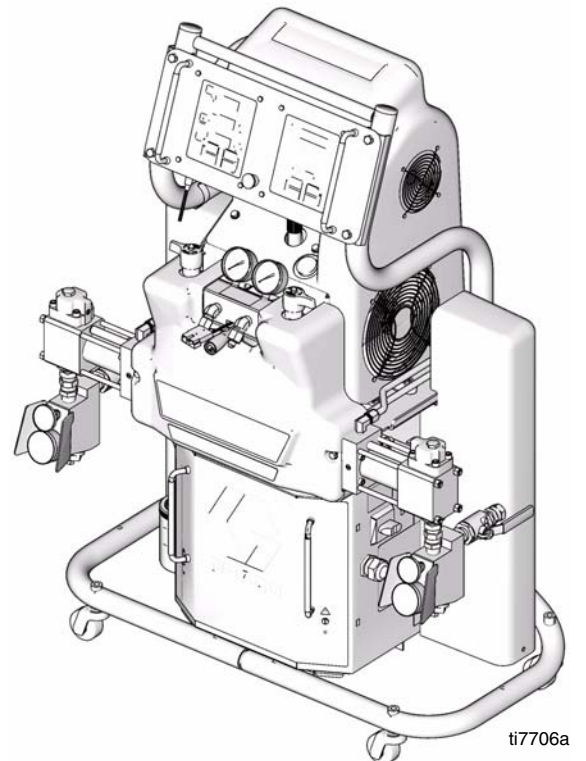

GRACO | GUSMER

PROVEN QUALITY. LEADING TECHNOLOGY.

Contents

Models	3	Maintenance	33
Supplied Manuals	4	Fluid Inlet Strainer Screen	33
Related Manuals	4	Pump Lubrication System	34
Warnings	5	Flushing	35
Isocyanate Hazard	7	Dimensions	36
Material Self-ignition	7	Technical Data	37
Moisture Sensitivity of Isocyanates	7	Graco Standard Warranty	38
Keep Components A and B Separate	7	Graco Information	38
Foam Resins with 245 fa Blowing Agents	7		
Changing Materials	7		
Typical Installation, with circulation	8		
Typical Installation, without circulation	9		
Component Identification	10		
Temperature Controls and Indicators	12		
Main Power Switch	12		
Red Stop Button	12		
Actual Temperature Key/LED	12		
Target Temperature Key/LED	12		
Temperature Scale Keys/LEDs	12		
Heater Zone On/Off Keys/LEDs	13		
Temperature Arrow Keys	13		
Temperature Displays	13		
Circuit Breakers	13		
Motor Controls and Indicators	14		
Motor ON/OFF Key/LED	14		
PARK Key/LED	14		
PSI/BAR Keys/LEDs	14		
Pressure Key/LED	14		
Cycle Count Key/LED	14		
Hydraulic Pressure Control Knob	15		
Motor Control Arrow Keys	15		
Spray Adjustments	15		
Setup	16		
Startup	22		
Spraying	26		
Standby	28		
Shutdown	28		
Pressure Relief Procedure	29		
Fluid Circulation	30		
Circulation Through Reactor	30		
Circulation Through Gun Manifold	31		
Diagnostic Codes	32		
Temperature Control Diagnostic Codes	32		
Motor Control Diagnostic Codes	32		

Models

H-25 SERIES

Part No., Series	Full Load Peak Amps*	Voltage (phase)	System Watts**	Primary Heater Watts	Flow lb/min (kg/min) at 35 cpm	Output per Cycle (A+B) gal. (liter)	Pressure Ratio	Maximum Fluid Working Pressure psi (MPa, bar)
253200, A	63	230V (1)	14,700	8000	22 (10)	0.063 (0.24)	1.91:1	2000 (13.8, 138)
253201, A	40	230V (3)	14,700	8000	22 (10)	0.063 (0.24)	1.91:1	2000 (13.8, 138)
253202, A	29	380V (3)	14,700	8000	22 (10)	0.063 (0.24)	1.91:1	2000 (13.8, 138)
253206, A	95	230V (1)	22,000	15,300	22 (10)	0.063 (0.24)	1.91:1	2000 (13.8, 138)
253207, A	58	230V (3)	22,000	15,300	22 (10)	0.063 (0.24)	1.91:1	2000 (13.8, 138)
253208, A	35	380V (3)	22,000	15,300	22 (10)	0.063 (0.24)	1.91:1	2000 (13.8, 138)
253300, A	69	230V (1)	15,960	8000	22 (10)	0.063 (0.24)	1.91:1	2000 (13.8, 138)
253301, A	45	230V (3)	15,960	8000	22 (10)	0.063 (0.24)	1.91:1	2000 (13.8, 138)
253302, A	35	380V (3)	15,960	8000	22 (10)	0.063 (0.24)	1.91:1	2000 (13.8, 138)
253306, A	100	230V (1)	23,260	15,300	22 (10)	0.063 (0.24)	1.91:1	2000 (13.8, 138)
253307, A	58	230V (3)	23,260	15,300	22 (10)	0.063 (0.24)	1.91:1	2000 (13.8, 138)
253308, A	35	380V (3)	23,260	15,300	22 (10)	0.063 (0.24)	1.91:1	2000 (13.8, 138)

H-XP2 SERIES

Part No., Series	Full Load Peak Amps*	Voltage (phase)	System Watts**	Primary Heater Watts	Flow gpm (lpm) at 35 cpm	Output per Cycle (A+B) gal. (liter)	Pressure Ratio	Maximum Fluid Working Pressure psi (MPa, bar)
253203, A	95	230V (1)	22,000	15,300	1.5 (5.7)	0.042 (0.16)	2.79:1	3500 (24.1, 241)
253204, A	58	230V (3)	22,000	15,300	1.5 (5.7)	0.042 (0.16)	2.79:1	3500 (24.1, 241)
253205, A	35	380V (3)	22,000	15,300	1.5 (5.7)	0.042 (0.16)	2.79:1	3500 (24.1, 241)
253303, A	100	230V (1)	23,260	15,300	1.5 (5.7)	0.042 (0.16)	2.79:1	3500 (24.1, 241)
253304, A	58	230V (3)	23,260	15,300	1.5 (5.7)	0.042 (0.16)	2.79:1	3500 (24.1, 241)
253305, A	35	380V (3)	23,260	15,300	1.5 (5.7)	0.042 (0.16)	2.79:1	3500 (24.1, 241)

* Full load amps with all devices operating at maximum capabilities. Fuse requirements at various flow rates and mix chamber sizes may be less.

** Total system watts, based on maximum hose length for each unit:

- Part Nos. 253200 through 253208, 210 ft (64 m) maximum heated hose length, including whip hose.
- Part Nos. 253300 through 253308, 310 ft (94.6 m) maximum heated hose length, including whip hose.

Supplied Manuals

The following manuals are shipped with the Reactor™ Proportioner. Refer to these manuals for detailed equipment information.

Order Part No. 15B535 for a compact disk of Reactor manuals translated in several languages.

Manuals are also available at www.graco.com.

Reactor Hydraulic Proportioner	
Part No.	Description
311300	Reactor Hydraulic Proportioner, Repair/Parts Manual (English)
Reactor Electrical Diagrams	
Part No.	Description
311508	Electrical Diagrams (English)
Proportioning Pump	
Part No.	Description
312068	Proportioning Pump Repair-Parts Manual (English)

Related Manuals

The following manuals are for accessories used with the Reactor™.

Order Part No. 15B535 for a compact disk of Reactor manuals translated in several languages.







Order Part No. 15B381 for a compact disk of Fusion manual translated in several languages.







Feed Pump Kits	
Part No.	Description
309815	Instruction-Parts Manual (English)
Air Supply Kit	
Part No.	Description
309827	Instruction-Parts Manual (English) for Feed Pump Air Supply Kit
Circulation and Return Tube Kits	
Part No.	Description
309852	Instruction-Parts Manual (English)
Heated Hose	
Part No.	Description
309572	Instruction-Parts Manual (English)

Fusion Air Purge Spray Gun	
Part No.	Description
309550	Instruction-Parts Manual (English)
Fusion Mechanical Purge Spray Gun	
Part No.	Description
309856	Instruction-Parts Manual (English)
Circulation Kit	
Part No.	Description
309818	Instruction-Parts Manual (English)
Data Reporting Kit	
Part No.	Description
309867	Instruction-Parts Manual (English)
Transformer Repair Kit	
Part No.	Description
309930	Instruction-Parts Manual (English)
Rupture Disk Assembly Kit	
Part No.	Description
309969	Instruction-Parts Manual (English)
Proportioning Pump Repair Kits	
Part No.	Description
312071	Instruction-Parts Manual (English)





Warnings

The following warnings are for the setup, use, grounding, maintenance, and repair of this equipment. The exclamation point symbol alerts you to a general warning and the hazard symbols refer to procedure-specific risks. Refer back to these Warnings. Additional, product-specific warnings may be found throughout the body of this manual where applicable.



 WARNING	
 	<p>ELECTRIC SHOCK HAZARD</p> <p>Improper grounding, setup, or usage of the system can cause electric shock.</p> <ul style="list-style-type: none"> • Turn off and disconnect power cord before servicing equipment. • Use only grounded electrical outlets. • Use only 3-wire extension cords. • Ensure ground prongs are intact on sprayer and extension cords. • Do not expose to rain. Store indoors.
	<p>TOXIC FLUID OR FUMES HAZARD</p> <p>Toxic fluids or fumes can cause serious injury or death if splashed in the eyes or on skin, inhaled, or swallowed.</p> <ul style="list-style-type: none"> • Read MSDS's to know the specific hazards of the fluids you are using. • Store hazardous fluid in approved containers, and dispose of it according to applicable guidelines.
	<p>PERSONAL PROTECTIVE EQUIPMENT</p> <p>You must wear appropriate protective equipment when operating, servicing, or when in the operating area of the equipment to help protect you from serious injury, including eye injury, inhalation of toxic fumes, burns, and hearing loss. This equipment includes but is not limited to:</p> <ul style="list-style-type: none"> • Protective eyewear • Clothing and respirator as recommended by the fluid and solvent manufacturer • Gloves • Hearing protection
 	<p>SKIN INJECTION HAZARD</p> <p>High-pressure fluid from gun, hose leaks, or ruptured components will pierce skin. This may look like just a cut, but it is a serious injury that can result in amputation. Get immediate surgical treatment.</p> <ul style="list-style-type: none"> • Do not point gun at anyone or at any part of the body. • Do not put your hand over the spray tip. • Do not stop or deflect leaks with your hand, body, glove, or rag. • Do not spray without tip guard and trigger guard installed. • Engage trigger lock when not spraying. • Follow Pressure Relief Procedure in this manual, when you stop spraying and before cleaning, checking, or servicing equipment.

 WARNING	
	<p>FIRE AND EXPLOSION HAZARD</p> <p>Flammable fumes, such as solvent and paint fumes, in work area can ignite or explode. To help prevent fire and explosion:</p> <ul style="list-style-type: none"> • Use equipment only in well ventilated area. • Eliminate all ignition sources; such as pilot lights, cigarettes, portable electric lamps, and plastic drop cloths (potential static arc). • Keep work area free of debris, including solvent, rags and gasoline. • Do not plug or unplug power cords, or turn power or light switches on or off when flammable fumes are present. • Ground all equipment in the work area. See Grounding instructions. • Use only grounded hoses. • Hold gun firmly to side of grounded pail when triggering into pail. • If there is static sparking or you feel a shock, stop operation immediately. Do not use equipment until you identify and correct the problem. • Keep a working fire extinguisher in the work area.
	<p>PRESSURIZED ALUMINUM PARTS HAZARD</p> <p>Do not use 1,1,1-trichloroethane, methylene chloride, other halogenated hydrocarbon solvents or fluids containing such solvents in pressurized aluminum equipment. Such use can cause serious chemical reaction and equipment rupture, and result in death, serious injury, and property damage.</p>
	<p>EQUIPMENT MISUSE HAZARD</p> <p>Misuse can cause death or serious injury.</p> <ul style="list-style-type: none"> • Do not operate the unit when fatigued or under the influence of drugs or alcohol. • Do not exceed the maximum working pressure or temperature rating of the lowest rated system component. See Technical Data in all equipment manuals. • Use fluids and solvents that are compatible with equipment wetted parts. See Technical Data in all equipment manuals. Read fluid and solvent manufacturer's warnings. For complete information about your material, request MSDS forms from distributor or retailer. • Check equipment daily. Repair or replace worn or damaged parts immediately with genuine manufacturer's replacement parts only. • Do not alter or modify equipment. • Use equipment only for its intended purpose. Call your distributor for information. • Route hoses and cables away from traffic areas, sharp edges, moving parts, and hot surfaces. • Do not kink or over bend hoses or use hoses to pull equipment. • Keep children and animals away from work area. • Comply with all applicable safety regulations.
	<p>MOVING PARTS HAZARD</p> <p>Moving parts can pinch or amputate fingers and other body parts.</p> <ul style="list-style-type: none"> • Keep clear of moving parts. • Do not operate equipment with protective guards or covers removed. • Pressurized equipment can start without warning. Before checking, moving, or servicing equipment, follow the Pressure Relief Procedure in this manual. Disconnect power or air supply.
	<p>BURN HAZARD</p> <p>Equipment surfaces and fluid that's heated can become very hot during operation. To avoid severe burns, do not touch hot fluid or equipment. Wait until equipment/fluid has cooled completely.</p>

Isocyanate Hazard

						
<p>Read material manufacturer's warnings and material MSDS to know the specific hazards of isocyanates. Use equipment in a well-ventilated area. Wear respirator, gloves, and protective clothing when using isocyanates.</p>						

Material Self-ignition

						
<p>Some materials may become self-igniting if applied too thickly. Read material manufacturer's warnings and material MSDS.</p>						

Moisture Sensitivity of Isocyanates

Isocyanates (ISO) are catalysts used in two component foam and polyurea coatings. ISO will react with moisture (such as humidity) to form small, hard, abrasive crystals, which become suspended in the fluid. Eventually a film will form on the surface and the ISO will begin to gel, increasing in viscosity. If used, this partially cured ISO will reduce performance and the life of all wetted parts.

 The amount of film formation and rate of crystallization varies depending on the blend of ISO, the humidity, and the temperature.

To prevent exposing ISO to moisture:

- Always use a sealed container with a desiccant dryer in the vent, or a nitrogen atmosphere. **Never** store ISO in an open container.
- Keep the ISO lube pump reservoir filled with Graco Throat Seal Liquid (TSL), Part No. 206995. The lubricant creates a barrier between the ISO and the atmosphere.
- Use moisture-proof hoses specifically designed for ISO, such as those supplied with your system.

- Never use reclaimed solvents, which may contain moisture. Always keep solvent containers closed when not in use.
- Never use solvent on one side if it has been contaminated from the other side.
- Always park pumps when you shutdown, see page 28.
- Always lubricate threaded parts with Part No. 217374 ISO pump oil or grease when reassembling.

Keep Components A and B Separate

CAUTION
<p>To prevent cross-contamination of the equipment's wetted parts, never interchange component A (isocyanate) and component B (resin) parts.</p>

Foam Resins with 245 fa Blowing Agents

New foam blowing agents will froth at temperatures above 90°F (33°C) when not under pressure, especially if agitated. To reduce frothing, minimize preheating in a circulation system.

Changing Materials

- When changing materials, flush the equipment multiple times to ensure it is thoroughly clean.
- Always clean the fluid inlet strainers after flushing, see page 33.
- Check with your material manufacturer for chemical compatibility.
- Most materials use ISO on the A side, but some use ISO on the B side.
- Epoxies often have amines on the B (hardener) side. Polyureas often have amines on the B (resin) side.

Typical Installation, with circulation

Key for FIG. 1

- | | | | |
|---|--------------------------------|---|---|
| A | Reactor Proportioner | G | Feed Pump Air Supply Lines |
| B | Heated Hose | J | Fluid Supply Lines |
| C | Fluid Temperature Sensor (FTS) | K | Feed Pumps |
| D | Heated Whip Hose | L | Agitator |
| E | Fusion Spray Gun | M | Desiccant Dryer |
| F | Gun Air Supply Hose | P | Gun Fluid Manifold (part of Fusion gun) |
| | | R | Circulation Lines |

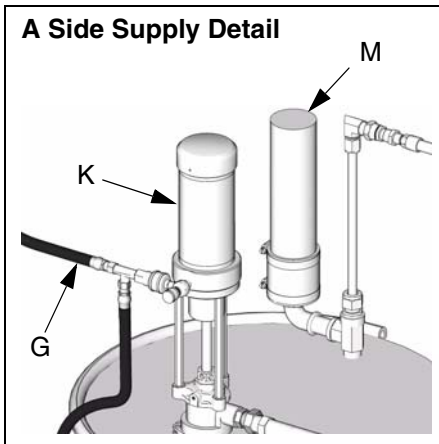

ti7820a 3

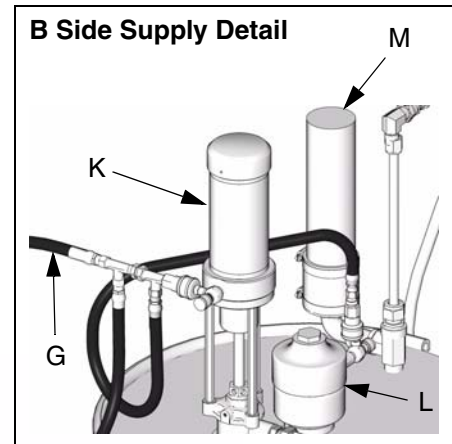

ti7820a 2

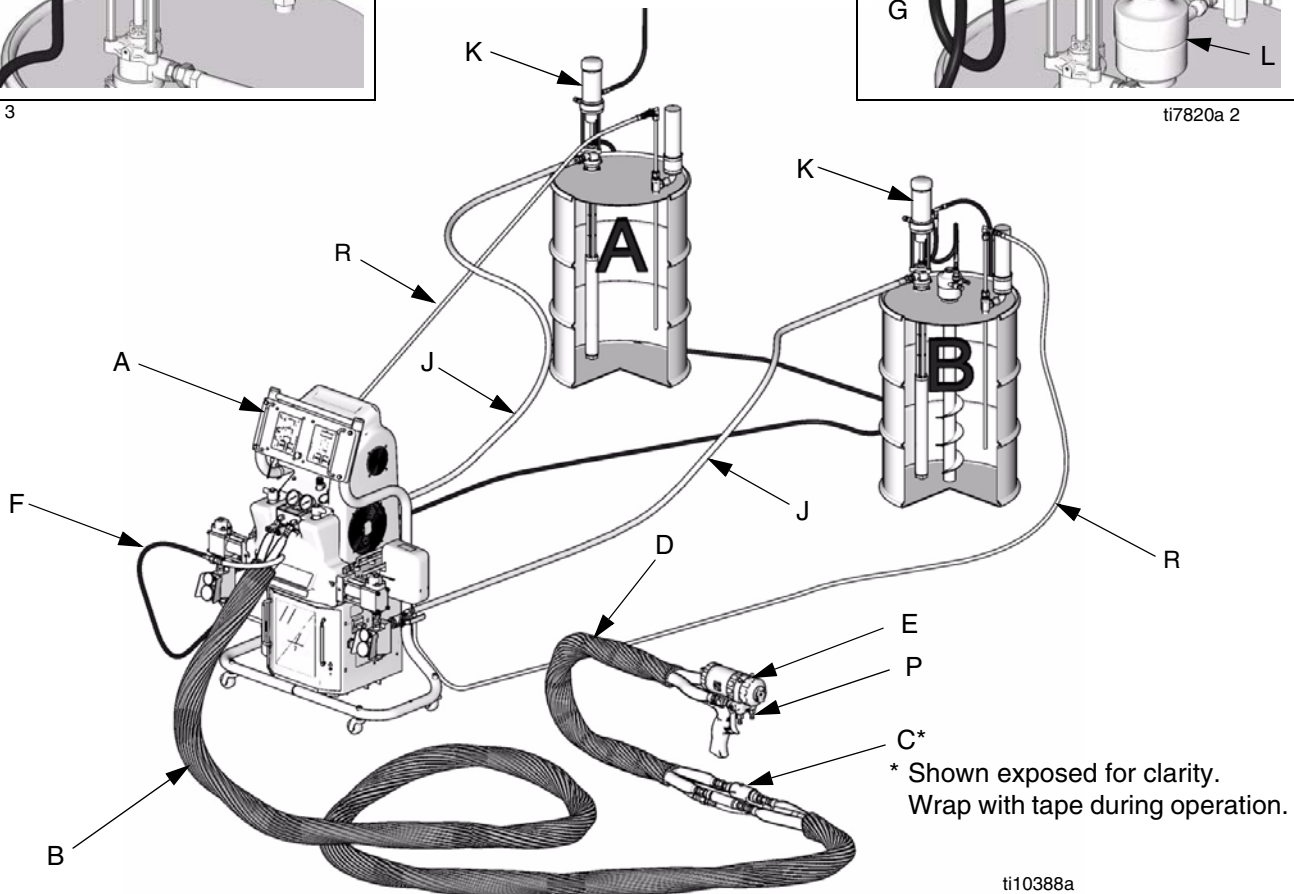

ti10388a

FIG. 1: Typical Installation, with circulation

Typical Installation, without circulation

Key for FIG. 2

- | | | | |
|---|--------------------------------|---|---|
| A | Reactor Proportioner | H | Waste Containers |
| B | Heated Hose | J | Fluid Supply Lines |
| C | Fluid Temperature Sensor (FTS) | K | Feed Pumps |
| D | Heated Whip Hose | L | Agitator |
| E | Fusion Spray Gun | M | Desiccant Dryer |
| F | Gun Air Supply Hose | N | Bleed Lines |
| G | Feed Pump Air Supply Lines | P | Gun Fluid Manifold (part of Fusion gun) |

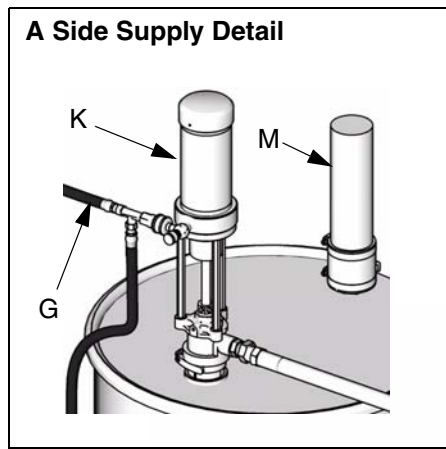

ti7821a 2

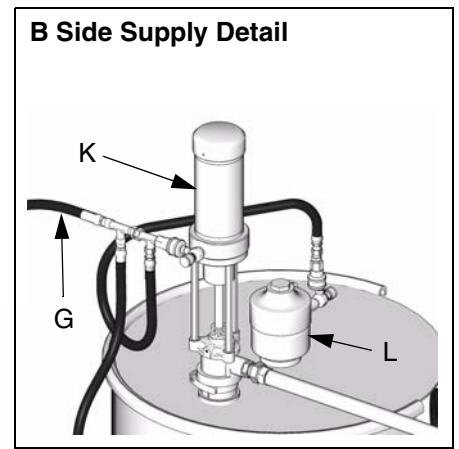

ti7821a 3

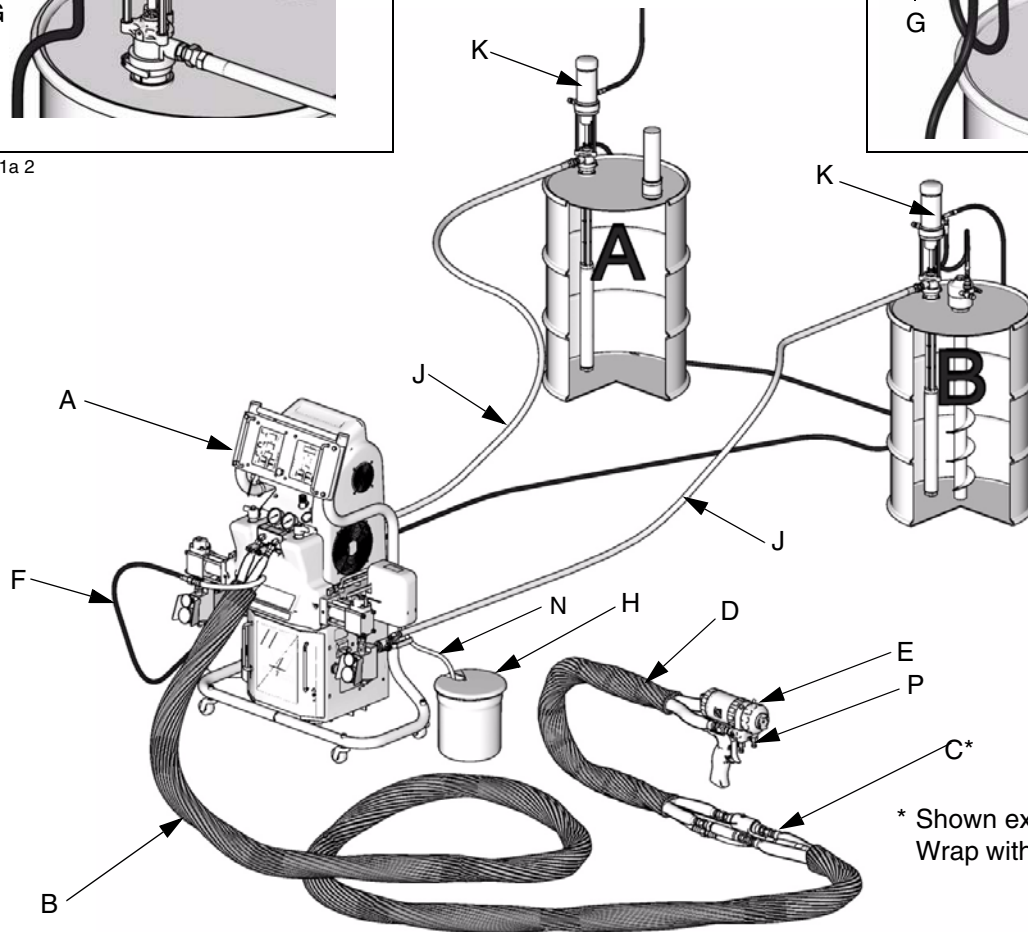

* Shown exposed for clarity.
Wrap with tape during operation.

ti7821a 1, 2, 3

FIG. 2: Typical Installation, without circulation

Component Identification

Key for FIG. 3

BA	Component A Pressure Relief Outlet
BB	Component B Pressure Relief Outlet
EC	Heated Hose Electrical Connector
EM	Electric Motor, Fan, and Belt Drive (behind shroud)
FA	Component A Fluid Manifold Inlet (on left side of manifold block)
FB	Component B Fluid Manifold Inlet
FH	Fluid Heater (behind shroud)
FM	Reactor Fluid Manifold
FP	Feed Inlet Pressure Gauge
FS	Feed Inlet Strainer
FT	Feed Inlet Temperature Gauge
FV	Fluid Inlet Valve (B side shown)
GA	Component A Outlet Pressure Gauge
GB	Component B Outlet Pressure Gauge
HA	Component A Hose Connection
HB	Component B Hose Connection
HC	Hydraulic Pressure Control
HP	Hydraulic Pressure Gauge
LR	ISO Lube Pump Reservoir
MC	Motor Control Display
MP	Main Power Switch
OP	Overpressure Rupture Disk Assembly (on rear of A and B pumps)
PA	Component A Pump
PB	Component B Pump
RS	Red Stop Button
SA	Component A PRESSURE RELIEF/SPRAY Valve
SB	Component B PRESSURE RELIEF/SPRAY Valve
SC	Fluid Temperature Sensor Cable
SN	Serial Number Plate (one inside cabinet, one on right side of cabinet)
SR	Electrical Cord Strain Relief
TA	Component A Pressure Transducer (behind gauge GA)
TB	Component B Pressure Transducer (behind gauge GB)
TC	Temperature Control Display

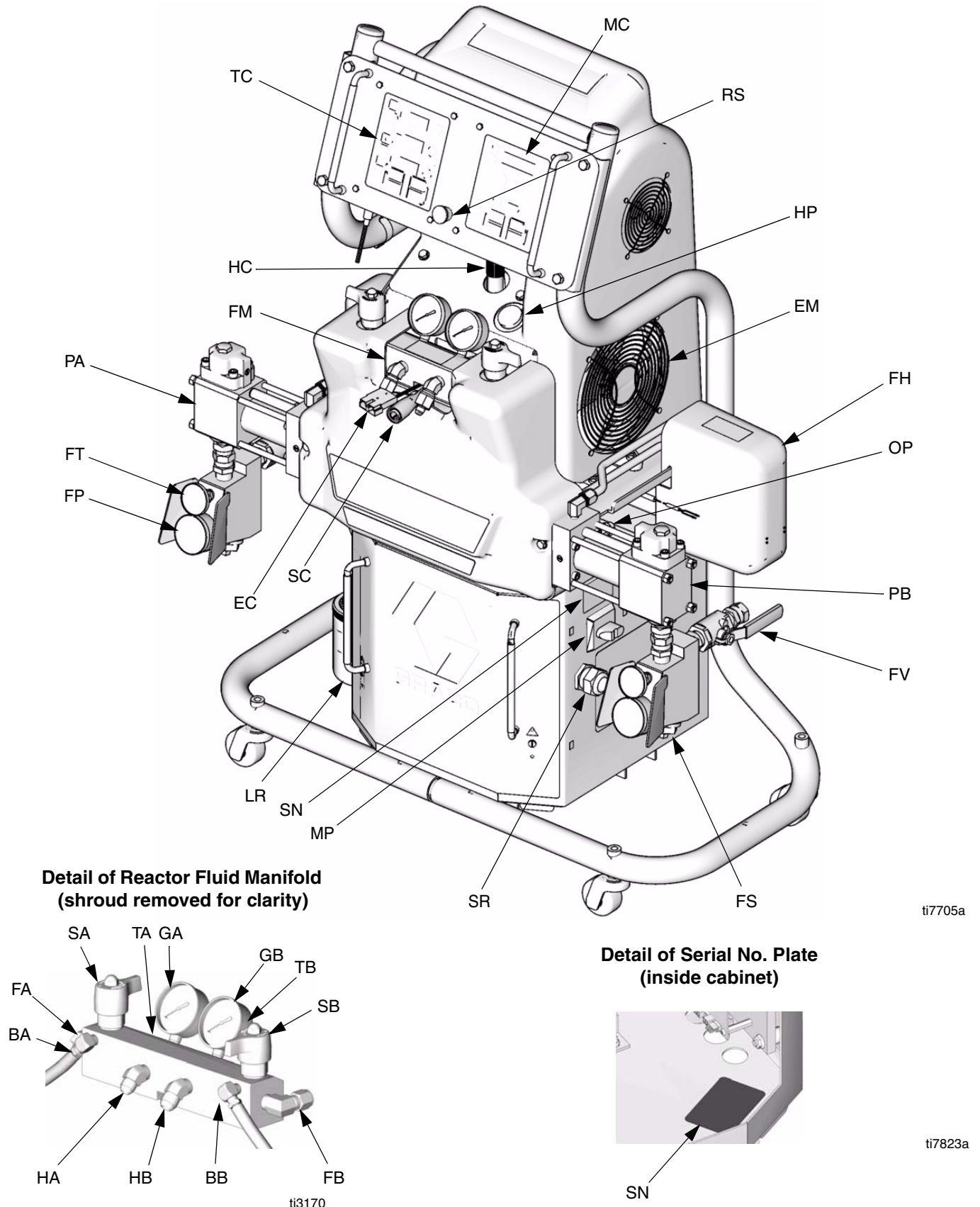

ti7705a

ti7823a

ti3170

FIG. 3: Component Identification (H-25 8 kW Model Shown)

Temperature Controls and Indicators

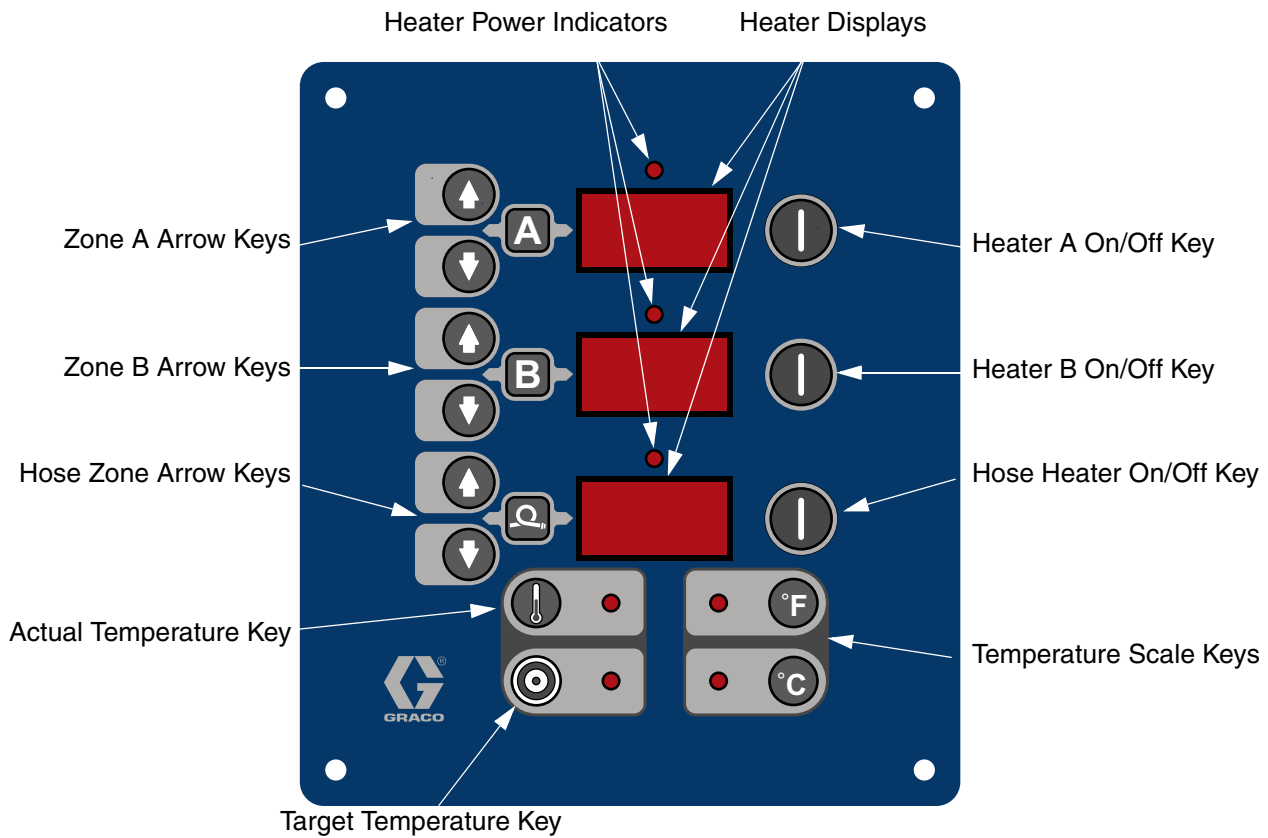

FIG. 4. Temperature Controls and Indicators

Main Power Switch

Located on right side of unit, page 11. Turns Reactor

power ON  and OFF . Does not turn heater zones or pumps on.

Red Stop Button

Located between temperature control panel and motor

control panel, page 11. Press  to shut off motor and heater zones only. Use main power switch to shut off all power to unit.



Actual Temperature Key/LED

Press  to display actual temperature.

Target Temperature Key/LED

Press  to display target temperature.

Temperature Scale Keys/LEDs

Press  or  to change temperature scale.



Heater Zone On/Off Keys/LEDs

Press  to turn heater zones on and off. Also clears heater zone diagnostic codes, see page 32.

LEDs are on steady when heater zones are powering up. They begin flashing as heat reaches targets.

 LEDs will also flash if cutback point is reached.

Temperature Arrow Keys

Press , then press  or  to adjust temperature settings in 1 degree increments.

Temperature Displays

Show actual temperature or target temperature of heater zones, depending on selected mode. Defaults to actual at startup. Range is 32-190°F (0-88°C) for A and B, 32-180°F (0-82°C) for hose.

Circuit Breakers



Located inside Reactor cabinet.

Ref.	Size	Component
CB1	50 A	Hose/Transformer Secondary
CB2	20 A	Transformer Primary
CB3	25 or 40 A*	Heater A
CB4	25 or 40 A*	Heater B
CB5	20 A	Motor/Pumps

* Depending on model.

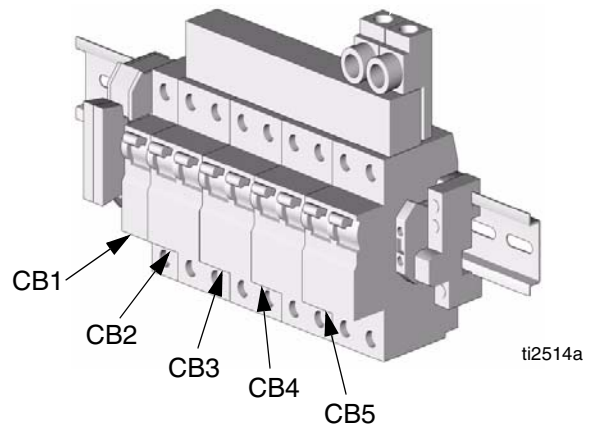

For wiring and cabling, see repair manual.

Motor Controls and Indicators

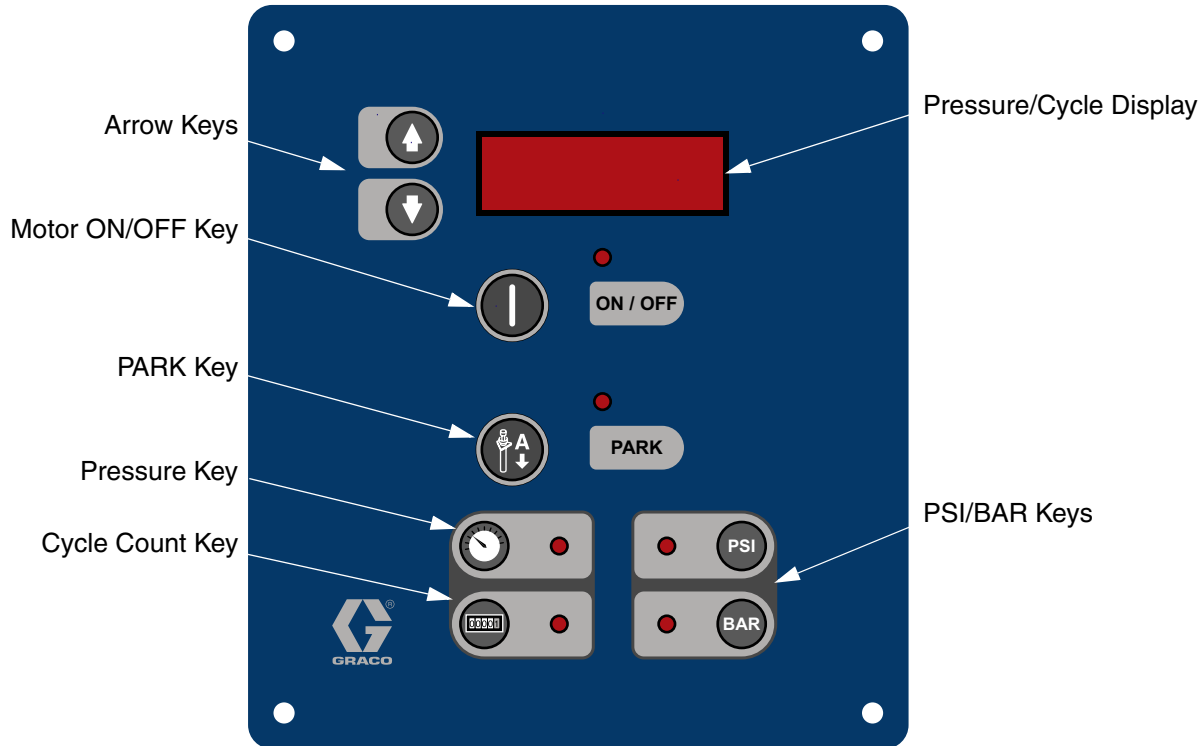



FIG. 5. Motor Controls and Indicators



Motor ON/OFF Key/LED

Press  to turn motor ON and OFF. Also clears some motor control diagnostic codes, see page 32.

PARK Key/LED

Press  at end of day to cycle component A pump to home position, submerging displacement rod. Trigger gun until pump stops. Once parked, motor will automatically shut off.

PSI/BAR Keys/LEDs

Press  or  to change pressure scale.



Pressure Key/LED

Press  to display fluid pressure.

 If pressures are imbalanced, display shows higher of two pressures.

Cycle Count Key/LED

Press  to display cycle count.

 To clear counter, press and hold  for 3 sec.

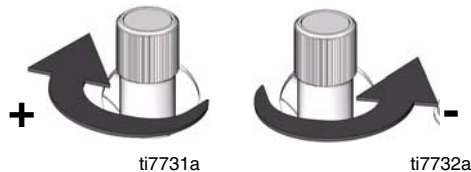

Hydraulic Pressure Control Knob

Use to adjust hydraulic pressure available to the hydraulic drive system. Turn knob (HC) clockwise to increase pressure and counterclockwise to decrease pressure. Use hydraulic pressure gauge (HP, page 11) to view hydraulic pressure.



 Component A and B outlet pressures will be higher than the hydraulic set pressure, depending on the model (see Pressure Ratio data on page 3). Component A and B pressure may be viewed on the pressure gauges (GA, GB), or the higher of the two pressures may be displayed on the motor control panel (MC). See FIG. 3, page 11.

Motor Control Arrow Keys

Use  or  to:

- Adjust pressure imbalance settings, page 25.
- Adjust standby settings, page 28.

Spray Adjustments

Flow rate, atomization, and amount of overspray are affected by four variables.

- **Fluid pressure setting.** Too little pressure results in an uneven pattern, coarse droplet size, low flow, and poor mixing. Too much pressure results in excessive overspray, high flow rates, difficult control, and excessive wear.
- **Fluid temperature.** Similar effects to fluid pressure setting. The A and B temperatures can be offset to help balance the fluid pressure.
- **Mix chamber size.** Choice of mix chamber is based on desired flow rate and fluid viscosity.
- **Cleanoff air adjustment.** Too little cleanoff air results in droplets building up on the front of the nozzle, and no pattern containment to control overspray. Too much cleanoff air results in air-assisted atomization and excessive overspray.

Setup

1. Locate Reactor

- a. Locate Reactor on a level surface. See **Dimensions**, page 36, for clearance and mounting hole dimensions.
- b. Do not expose Reactor to rain.

CAUTION

Bolt Reactor to original shipping pallet before lifting.
--

- c. Use the casters to move Reactor to a fixed location, or bolt to shipping pallet and move with forklift.
- d. To mount on a truck bed or trailer, remove casters and bolt directly to truck or trailer bed. See page 36.

**Table 1: Electrical Requirements
(kW/Full Load Amps)**

Part No.	Model	Voltage (phase)	Full Load Peak Amps*	System Watts**
253200	H-25	230V (1)	63	14,700
253201	H-25	230V (3)	40	14,700
253202	H-25	380V (3)	29	14,700
253203	H-XP2	230V (1)	95	22,000
253204	H-XP2	230V (3)	58	22,000
253205	H-XP2	380V (3)	35	22,000
253206	H-25	230V (1)	95	22,000
253207	H-25	230V (3)	58	22,000
253208	H-25	380V (3)	35	22,000
253300	H-25	230V (1)	69	15,960
253301	H-25	230V (3)	45	15,960
253302	H-25	380V (3)	35	15,960
253303	H-XP2	230V (1)	100	23,260
253304	H-XP2	230V (3)	58	23,260
253305	H-XP2	380V (3)	35	23,260
253306	H-25	230V (1)	100	23,260
253307	H-25	230V (3)	58	23,260
253308	H-25	380V (3)	35	23,260



* Full load amps with all devices operating at maximum capabilities. Fuse requirements at various flow rates and mix chamber sizes may be less.

** Total system watts, based on maximum hose length for each unit:

- Part Nos. 253200 through 253208, 210 ft (64 m) maximum heated hose length, including whip hose.
- Part Nos. 253300 through 253308, 310 ft (94.6 m) maximum heated hose length, including whip hose.

2. Electrical requirements

See TABLE 1.

						
<p>Installing this equipment requires access to parts which may cause electric shock or other serious injury if work is not performed properly. Have a qualified electrician connect power and ground to main power switch terminals, see page 17. Be sure your installation complies with all National, State and Local safety and fire codes.</p>						

3. Connect electrical cord

 Power cord is not supplied. See TABLE 2.

Table 2: Power Cord Requirements

Part No.	Model	Cord Specification AWG (mm ²)
253200	H-25	6 (13.3), 2 wire + ground
253201	H-25	10 (5.3), 3 wire + ground
253202	H-25	10 (5.3), 4 wire + ground
253203	H-XP2	4 (21.2), 2 wire + ground
253204	H-XP2	8 (8.4), 3 wire + ground
253205	H-XP2	10 (5.3), 4 wire + ground
253206	H-25	4 (21.2), 2 wire + ground
253207	H-25	8 (8.4), 3 wire + ground
253208	H-25	10 (5.3), 4 wire + ground
253300	H-25	6 (13.3), 2 wire + ground
253301	H-25	8 (8.4), 3 wire + ground
253302	H-25	10 (5.3), 4 wire + ground
253303	H-XP2	4 (21.2), 2 wire + ground
253304	H-XP2	8 (8.4), 3 wire + ground
253305	H-XP2	10 (5.3), 4 wire + ground
253306	H-25	4 (21.2), 2 wire + ground
253307	H-25	8 (8.4), 3 wire + ground
253308	H-25	10 (5.3), 4 wire + ground



- a. 230V, 1 phase:** Using 5/32 or 4 mm hex allen wrench, connect two power leads to L1 and L2. Connect green to ground (GND).

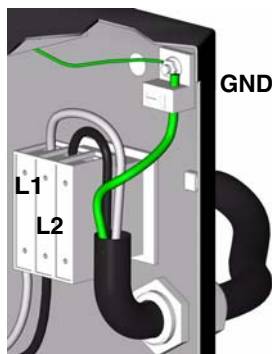

ti2515b

- b. 230V, 3 phase:** Using 5/32 or 4 mm hex allen wrench, connect three power leads to L1, L2, and L3. Connect green to ground (GND).

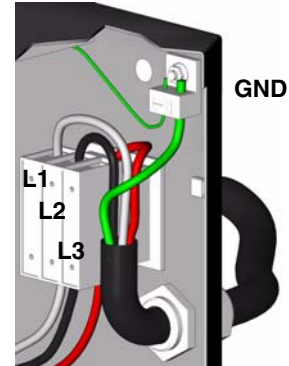

ti3248b

- c. 380V, 3 phase:** Using 5/32 or 4 mm hex allen wrench, connect three power leads to L1, L2, and L3. Connect neutral to N. Connect green to ground (GND).

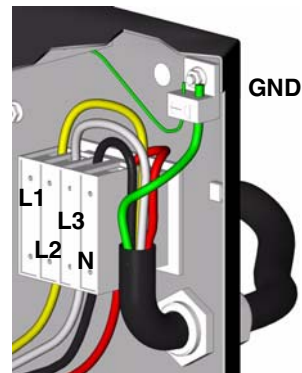

ti2725a

4. Connect feed pumps

- a.** Install feed pumps (K) in component A and B supply drums. See FIG. 1 and FIG. 2, pages 8 and 9.

 A minimum feed pressure of 50 psi (0.35 MPa, 3.5 bar) is required at both feed inlet pressure gauges (FP). Maximum feed pressure is 250 psi (1.75 MPa, 17.5 bar). Maintain A and B feed pressures within 10% of each other.

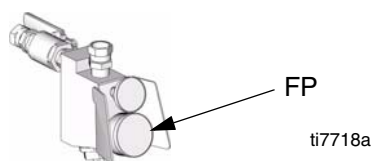

- b.** Seal component A drum and use desiccant dryer (M) in vent.
- c.** Install agitator (L) in component B drum, if necessary.
- d.** Ensure A and B inlet valves (FV) are closed.

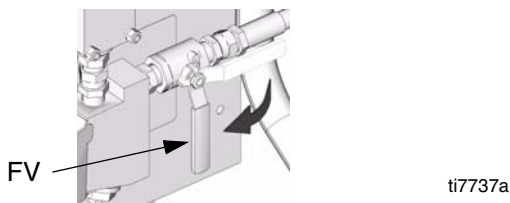



 Supply hoses from feed pumps should be 3/4 in. (19 mm) ID.

- e.** Connect and tighten component B supply hose to the 3/4 npt(f) swivel on the component B inlet valve.

- f.** Connect and tighten component A supply hose to the 1/2 npt(f) swivel on the component A inlet valve.

5. Connect pressure relief lines

						
---	---	--	--	--	--	--

Do not install shutoffs downstream of the PRESSURE RELIEF/SPRAY valve outlets (BA, BB, page 11). The valves function as overpressure relief valves when set to SPRAY. Lines must be open so valves can automatically relieve pressure when machine is operating.

If circulating fluid back to the supply drums, use high pressure hose rated to withstand the maximum working pressure of this equipment.

- a. Recommended:** Connect high pressure hose (R) to relief fittings (BA, BB) of both PRESSURE RELIEF/SPRAY valves, Route hose back to component A and B drums. See FIG. 1, page 8.

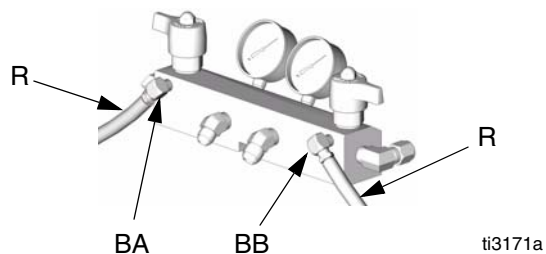

- b. Alternately:** Secure supplied bleed tubes (N) in grounded, sealed waste containers (H). See FIG. 2, page 9.

6. Install Fluid Temperature Sensor (FTS)

The Fluid Temperature Sensor (FTS) is supplied. Install FTS between main hose and whip hose. See Heated Hose manual 309572 for instructions.

7. Connect heated hose

See 309572 for detailed instructions for Graco heated hoses.

CAUTION

The fluid temperature sensor (C) and whip hose (D) must be used with heated hose, see page 19. Hose length, including whip hose, must be 60 ft (18.3 m) minimum.

- a. Turn main power OFF

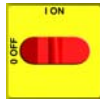

- b. Assemble heated hose sections, FTS, and whip hose.
- c. Connect A and B hoses to A and B outlets on Reactor fluid manifold (FM). Hoses are color coded: red for component A (ISO), blue for component B (RES). Fittings are sized to prevent connection errors.

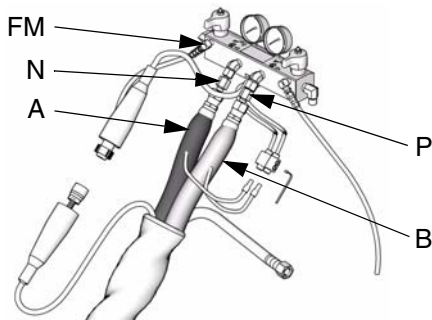

ti9878a

Manifold hose adapters (N, P) allow use of 1/4 in. and 3/8 in. ID fluid hoses. To use 1/2 in. (13 mm) ID fluid hoses, remove adapters from fluid manifold and install as needed to connect whip hose.

- d. Connect cables (Y). Connect electrical connectors (V). Secure with plastic ties. Be sure cables have slack when hose bends. Wrap cable and electrical connections with electrical tape.

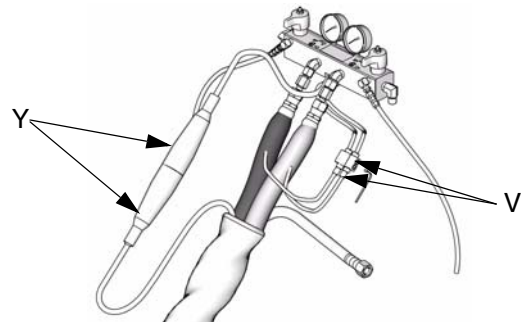

ti2727a

8. Close gun fluid manifold valves A and B

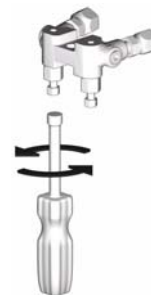

ti2411a

9. Connect whip hose to gun fluid manifold

Do not connect manifold to gun.

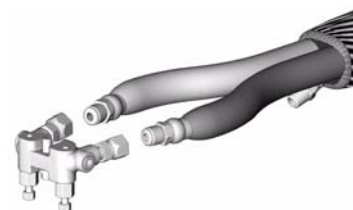

ti2417a

10. Pressure check hose

See hose manual. Pressure check for leaks. If no leaks, wrap hose and electrical connections to protect from damage.

11. Set transformer wire taps



Turn main power switch OFF . Transformer wire tap connections vary depending on length of heated hose. See FIG. 6 or FIG. 7. Verify that wire taps are correct.

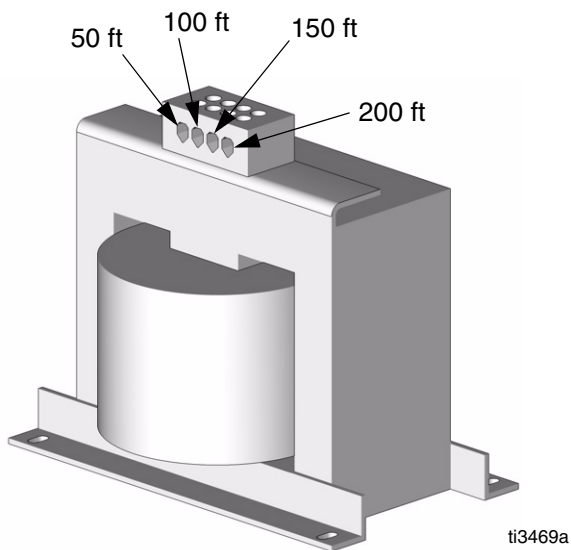

Hose Length* ft (m)	Tap Terminal Label (ft)
60-85 (18.3-25.9)	50
110-135 (33.5-41.2)	100
160-185 (48.8-56.4)	150
210-235 (64.1-71.7)	200

* Length includes heated fluid hose and whip hose.

FIG. 6: Transformer Wire Taps, Units with Part No. 15B351 Transformer

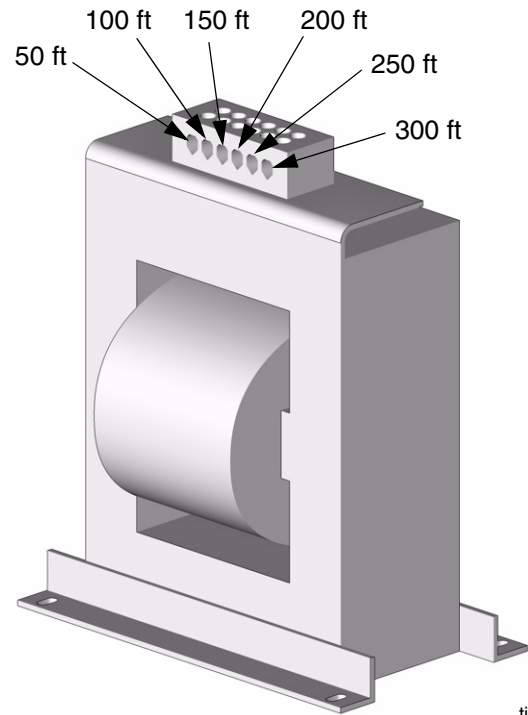

Hose Length* ft (m)	Tap Terminal Label (ft)
60-85 (18.3-25.9)	50
110-135 (33.5-41.2)	100
160-185 (48.8-56.4)	150
210-235 (64.1-71.7)	200
260-285 (79.3-86.9)	250
310 (94.6)	300

* Length includes heated fluid hose and whip hose.

FIG. 7: Transformer Wire Taps, Units with Part No. 15B352 Transformer

12. Ground system



- a. *Reactor*: is grounded through power cord. See page 17.
- b. *Spray gun*: connect whip hose ground wire to FTS, page 19. Do not disconnect wire or spray without whip hose.
- c. *Fluid supply containers*: follow your local code.
- d. *Object being sprayed*: follow your local code.
- e. *Solvent pails used when flushing*: follow your local code. Use only metal pails, which are conductive, placed on a grounded surface. Do not place pail on a nonconductive surface, such as paper or cardboard, which interrupts grounding continuity.
- f. *To maintain grounding continuity when flushing or relieving pressure*, hold a metal part of spray gun firmly to the side of a grounded *metal* pail, then trigger gun.

13. Check hydraulic fluid level

Hydraulic reservoir is filled at the factory. Check fluid level before operating the first time, and weekly thereafter. See **Maintenance**, page 33.

14. Lubrication system setup

Component A (ISO) Pump: Fill ISO lube reservoir (LR) with Graco Throat Seal Liquid (TSL), Part No. 206995 (supplied).

- a. Lift the lubricant reservoir (LR) out of the bracket (RB) and remove the container from the cap.

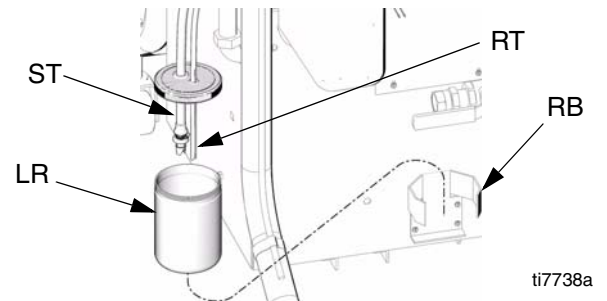



- b. Fill with fresh lubricant. Thread the reservoir onto the cap assembly and place it in the bracket (RB).
- c. Push the larger diameter supply tube (ST) approximately 1/3 of the way into the reservoir.
- d. Push the smaller diameter return tube (RT) into the reservoir until it reaches the bottom.

Important: The return tube (RT) must reach the bottom of the reservoir, to ensure that isocyanate crystals will settle to the bottom and not be siphoned into the supply tube (ST) and returned to the pump.

- e. The lubrication system is ready for operation. No priming is required.

Startup

WARNING

Do not operate Reactor without all covers and shrouds in place.

1. Fluid Temperature Sensor (FTS) Calibration

 Calibrate the FTS **ONLY** at initial startup (the first time the unit is operated) and any time the hose length changes.

- a.** Before turning on the unit, ensure all hoses and cables are properly connected. To ensure that the FTS in the hose is at the same temperature as the heaters, keep heat off and store the hose FTS near the machine for several minutes.
- b.** While holding down the temperature unit button (Fahrenheit - "F" or Celsius - "C") turn the Reactor main power ON.
- c.** Hold the temperature unit button until temperature is shown on the display. The fluid temperature sensor is now correctly calibrated.

1. Load fluid with feed pumps

 The Reactor is tested with oil at the factory. Flush out the oil with a compatible solvent before spraying. See page 35.

- a.** Check that **Setup** steps 1-14 are complete, pages 16-21.
- b.** Check that inlet screens are clean before daily startup, page 33.

- c.** Check level and condition of ISO lube daily, page 34.
- d.** Turn on component B agitator, if used.
- e.** Turn both PRESSURE RELIEF/SPRAY valves (SA, SB) to SPRAY.

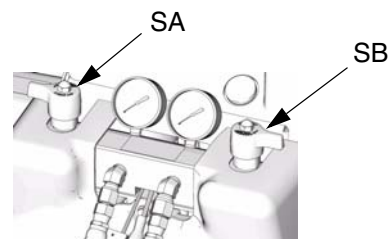



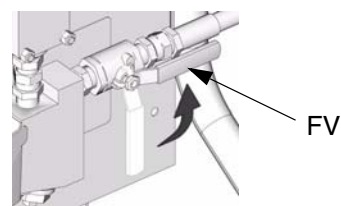

ti7739a

- f.** Start feed pumps.
- g.** Open fluid inlet valves (FV). Check for leaks.



ti7736a

					
<p>Do not mix components A and B during startup. Always provide two grounded waste containers to keep component A and component B fluids separate.</p>					

- h.** Use feed pumps to load system. Hold gun fluid manifold over two grounded waste containers. Open fluid valves A and B until clean, air-free fluid comes from valves. Close valves.



ti2484a

2. Set temperatures

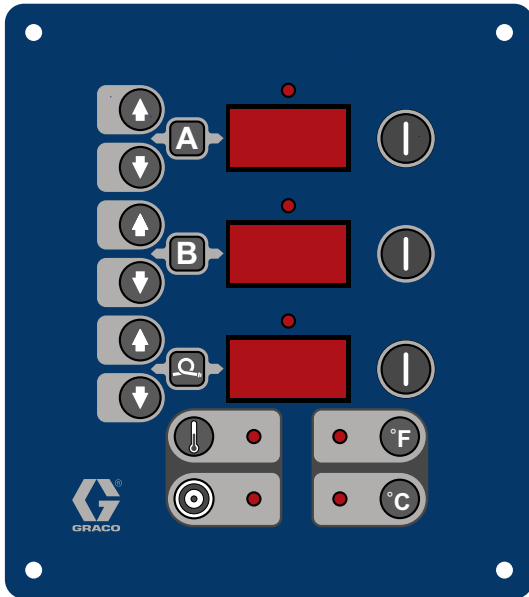

Temperature Controls and Indicators, see page 12

<p>This equipment is used with heated fluid, which can cause equipment surfaces to become very hot. To avoid severe burns:</p> <ul style="list-style-type: none"> Do not touch hot fluid or equipment. Allow equipment to cool completely before touching it. Wear gloves if fluid temperature exceeds 110°F (43°C). 						

- d.** To set **A** heat zone target temperature, press or until display shows desired temperature. Repeat for **B** and **Q** zones.

For **Q** zone only, if FTS is disconnected at startup, display will show hose current (0A). See step h, page 24.

- e.** Press to display actual temperatures.

Do not turn on hose heat without fluid in hoses.						

- f.** Turn on **Q** heat zone by pressing . Preheat hose (15-60 min). Indicator will flash very slowly when fluid reaches target temperature. Display shows actual fluid temperature in hose near FTS.

- a.** Turn main power ON

- b.** Press or to change temperature scale.

- c.** Press

<p>Thermal expansion can cause overpressurization, resulting in equipment rupture and serious injury, including fluid injection. Do not pressurize system when preheating hose.</p>						

g. Turn on **A** and **B** heat zones by pressing for each zone.

h. **Manual current control mode only:**

<p>When in manual current control mode, monitor hose temperature with thermometer. Install per instructions below. Thermometer reading must not exceed 160°F (71°C). Never leave machine unattended when in manual current control mode.</p>						

If FTS is disconnected or display shows diagnostic code E04, turn main power

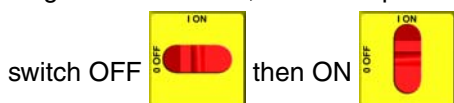

switch OFF then ON to clear diagnostic code and enter manual current control mode.

display will show current to hose. Current is not limited by target temperature.

To prevent overheating, install hose thermometer close to gun end, within operator view. Insert thermometer through foam cover of A component hose so stem is next to inner tube. Thermometer reading will be about 20°F less than actual fluid temperature.

If thermometer reading exceeds 160°F (71°C), reduce current with key.

3. Set pressure

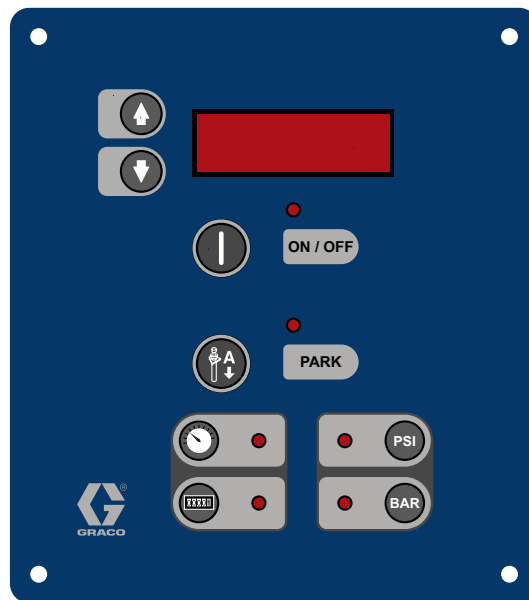

Motor Controls and Indicators, see page 14

a. Press to display the pressure reading.

b. Press motor . Motor and pumps start. Display shows system pressure.

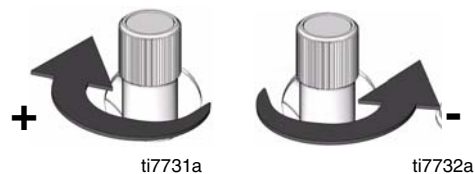

c. Adjust hydraulic pressure control until display shows desired fluid pressure.





If display pressure is greater than desired pressure, reduce the hydraulic pressure and trigger gun to reduce pressure.

 Check the pressure of each proportioning pump using the component A and B gauges. The pressures should be approximately equal and must remain fixed.

d. To display cycle count, press .

 To clear counter, press and hold  for 3 sec.

e. Press  or  to change pressure scale.

4. Change pressure imbalance setting (optional)

The pressure imbalance function (status code 24, page 32) detects conditions that can cause off-ratio spray, such as loss of feed pressure/supply, pump seal failure, clogged fluid inlet filter, or a fluid leak.

 Code 24 (pressure imbalance) is set to an alarm as the default. To change to a warning, see repair/parts manual 311300.

The pressure imbalance default is factory-set at 500 psi (3.5 MPa, 35 bar). For tighter ratio error detection, select a lower value. For looser detection or to avoid nuisance alarms, select a higher value.

a. Turn main power switch OFF .

b. Press and hold  or , then

turn main power switch ON .
Display will read dP500 for psi or dP_35 for bar.



c. Press  or  to select desired pressure differential (100-999 in increments of 100 psi, or 7-70 in increments of 7 bar). See TABLE 3.

Table 3: Available Pressure Imbalance Settings

PSI	BAR	PSI	BAR
100	7	600	42
200	14	700	49
300	21	800	56
400	28	900	63
*500	*35	999	69

* Factory default setting.

d. Turn main power switch OFF  to save changes.

Spraying



1. Engage gun piston safety lock.



ti2409a

2. Close gun fluid manifold valves A and B.



ti2728a

3. Attach gun fluid manifold. Connect gun air line. Open air line valve.

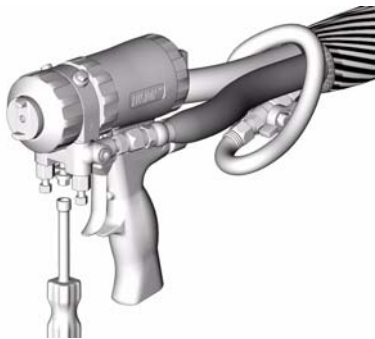

ti2543a

4. Set PRESSURE RELIEF/SPRAY valves (SA, SB) to SPRAY.

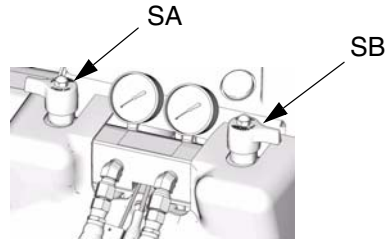

ti7739a

5. Check that heat zones are on and temperatures are on target, page 23.

6. Press motor  to start motor and pumps.

7. Check fluid pressure display and adjust as necessary, page 24.

8. Check fluid pressure gauges (GA, GB) to ensure proper pressure balance. If imbalanced, reduce pressure of higher component by **slightly** turning PRESSURE RELIEF/SPRAY valve for that component toward PRESSURE RELIEF, until gauges show balanced pressures.

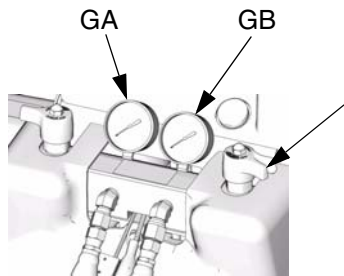

In this example, B side pressure is higher, so use the B side valve to balance pressures.

ti7741a

9. Open gun fluid manifold valves A and B.

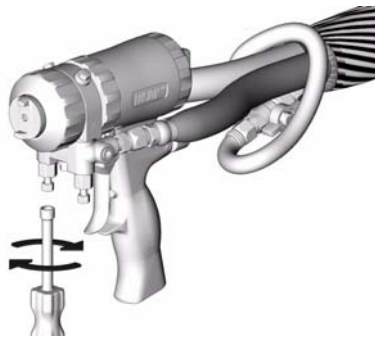

ti2414a

 On impingement guns, **never** open fluid manifold valves or trigger gun if pressures are imbalanced.

10. Disengage gun piston safety lock.



ti2410a

11. Test spray onto cardboard. Adjust pressure and temperature to get desired results.

12. Equipment is ready to spray.

 If you stop spraying for a period of time, the unit will enter standby (if enabled). See page 28.

Standby







If you stop spraying for a period of time, the unit will enter standby by shutting down the electric motor and hydraulic pump, to reduce equipment wear and minimize heat buildup. The ON/OFF LED and the pressure/cycle display on the motor control panel will flash when in standby.

 The **A** , **B** , and **Q** heat zones will not be shut off in standby.

To restart, spray off target for 2 sec. The system will sense the pressure drop and the motor will ramp up to full speed in a few seconds.

To activate or disable standby, adjust DIP switch #3 on the motor control board. See repair/parts manual 311300.

The idle time before entering standby is user-settable as follows:

1. Turn main power switch OFF .
2. Press and hold , then turn main power switch ON .
3. Press  or  to select desired timer setting (5-20, in 5 minute increments). This sets the length of inactive time before the unit will enter standby.
4. Turn main power switch OFF  to save changes.

Shutdown

1. Shut off **A** , **B** , and **Q** heat zones.
2. Park pumps.
 - a. Press .
 - b. Trigger gun until pump A stops in the retracted position and the pressure of both pumps bleeds down.

3. Turn main power OFF .

4. Close both fluid supply valves (FV).

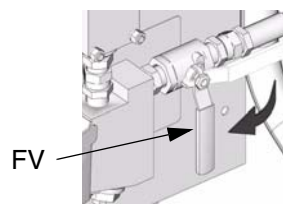

ti7737a

5. Relieve pressure, page 29.
6. Shut down feed pumps as required.

Pressure Relief Procedure



1. Relieve pressure in gun and perform gun shut-down procedure. See gun manual.

2. Close gun fluid manifold valves A and B.

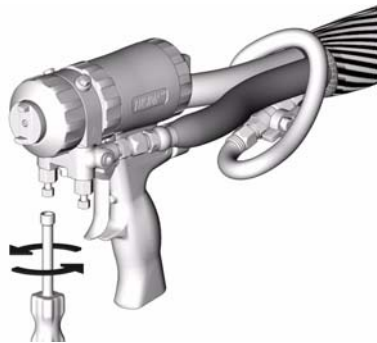

ti2421a

3. Shut off feed pumps and agitator, if used.

4. Turn PRESSURE RELIEF/SPRAY valves (SA, SB) to PRESSURE RELIEF. Route fluid to waste containers or supply tanks. Ensure gauges drop to 0.

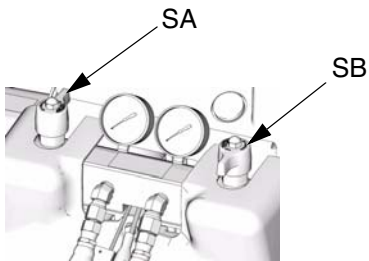

ti7740a

5. Engage gun piston safety lock.



ti2409a

6. Disconnect gun air line and remove gun fluid manifold.

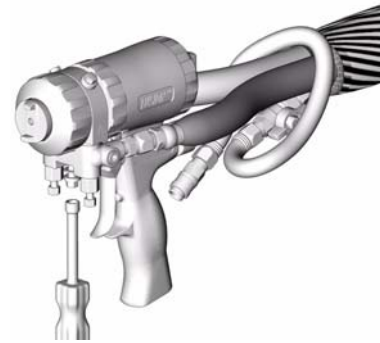

ti2554a

Fluid Circulation

Circulation Through Reactor

Do not circulate fluid containing a blowing agent without consulting with your material supplier regarding fluid temperature limits.						

To circulate through gun manifold and preheat hose, see page 31.

1. Load fluid with feed pumps, page 22.

Do not install shutoffs downstream of the PRESSURE RELIEF/SPRAY valve outlets (BA, BB). The valves function as overpressure relief valves when set to SPRAY. Lines must be open so valves can automatically relieve pressure when machine is operating.						

2. See Typical Installation, with circulation, page 8. Route circulation lines back to respective component A or B supply drum. Use hoses rated at the maximum working pressure of this equipment. See **Technical Data**, page 37.

3. Set PRESSURE RELIEF/SPRAY valves (SA, SB) to PRESSURE RELIEF.

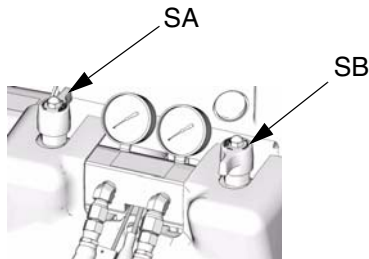

ti7740a

4. Turn main power ON

5. Set temperature targets, see page 23. Turn on

A and **B** heat zones by pressing

. **Do not** turn on heat zone unless hoses are already loaded with fluid.

6. Press to display actual temperatures.

7. Before starting motor, reduce hydraulic pressure to the minimum required to circulate fluid until

A and **B** temperatures reach targets.

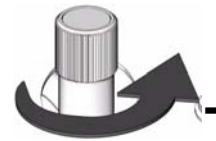

ti7732a

8. Press motor to start motor and pumps. Circulate fluid at lowest possible pressure until temperatures reach targets.

9. Turn on heat zone by pressing .

10. Set PRESSURE RELIEF/SPRAY valves (SA, SB) to SPRAY.

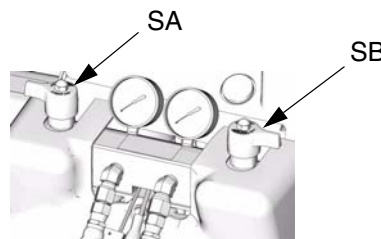

ti7739a

Circulation Through Gun Manifold

Do not circulate fluid containing a blowing agent without consulting with your material supplier regarding fluid temperature limits.						

Circulating fluid through the gun manifold allows rapid preheating of hose.

1. Install gun fluid manifold (P) on Part No. 246362 accessory circulation kit (CK). Connect high pressure circulation lines (R) to circulation manifold.

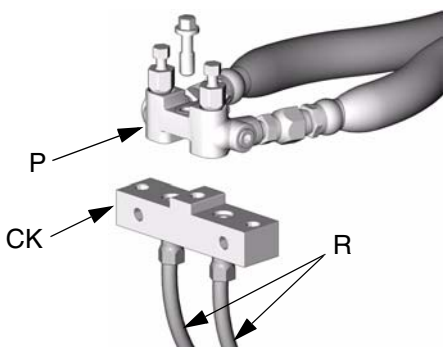

2. Route circulation lines back to respective component A or B supply drum. Use hoses rated at the maximum working pressure of this equipment. See **Typical Installation, without circulation**, page 9.

3. Follow **Load fluid with feed pumps**, page 22.

4. Turn main power ON .

5. Set temperature targets, see page 23. Turn on **A**, **B**, and **Q** heat zones by pressing .

6. Press  to display actual temperatures.

7. Before starting motor, reduce hydraulic pressure to the minimum required to circulate fluid until **A** and **B** temperatures reach targets.

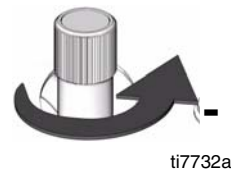

8. Press motor  to start motor and pumps. Circulate fluid at lowest possible pressure until temperatures reach targets.

Diagnostic Codes

Temperature Control Diagnostic Codes

Temperature control diagnostic codes E01 through E05 appear on temperature display.

These alarms turn off heat. Turn main power OFF



See repair manual for corrective action.

Code No.	Code Name	Alarm Zone
01	High fluid temperature	Individual
02	High hose current	Hose only
03	No hose current with hose heater on	Hose only
04	FTS or thermocouple not connected	Individual
05	Board overtemperature	All
30	Momentary loss of communication	All
99	Loss of communication	All

 For hose zone only, if FTS is disconnected at start-up, display will show hose current 0A.

Motor Control Diagnostic Codes

Motor control diagnostic codes E21 through E27 appear on pressure display.



There are two types of motor control codes: alarms and warnings. Alarms take priority over warnings.

See repair manual for corrective action.

Alarms

Alarms turn off Reactor. Turn main power OFF



 Alarms can also be cleared, except for code 23, by pressing .

 Code 24 (pressure imbalance) is set to an alarm default of 500 psi (3.5 MPa, 35 bar). To change to a warning, see repair/parts manual 311300. To change the default pressure imbalance setting, see page 25.

Warnings

Reactor will continue to run. Press  to clear. A warning will not recur for a predetermined amount of time (varies for different warnings), or until main power



Code No.	Code Name	Alarm or Warning
21	No transducer (component A)	Alarm
22	No transducer (component B)	Alarm
23	High pressure	Alarm
24	Pressure imbalance	Selectable; see repair manual
27	High motor temperature	Alarm
30	Momentary loss of communication	Alarm
31	Pumpline switch failure/high cycle rate	Alarm
99	Loss of communication	Alarm

Maintenance

- Inspect hydraulic and fluid lines for leaks daily.
- Clean up all hydraulic leaks; identify and repair cause of leak.
- Inspect fluid inlet strainer screens daily, see below.
- Inspect ISO lubricant level and condition daily, see page 34. Refill or replace as needed.
- Check hydraulic fluid level weekly. Remove cover plate (CP) and check hydraulic fluid level on dipstick (DS). Fluid level must be between indent marks (IM) on dipstick. Refill as required with approved hydraulic fluid; see **Technical Data** on page 37. If fluid is dark in color, change fluid and filter (see repair/parts manual 311300).

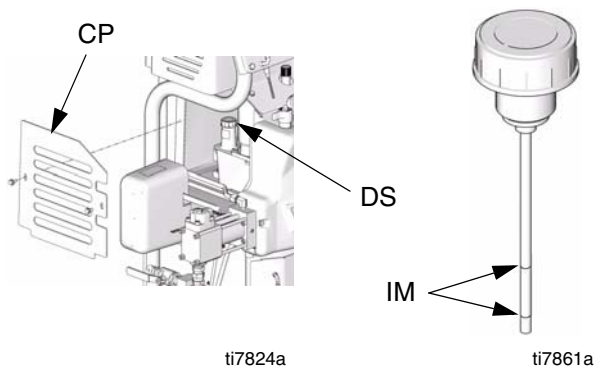

- Keep component A from exposure to moisture in atmosphere, to prevent crystallization.
- Clean gun mix chamber ports regularly. See gun manual.
- Clean gun check valve screens regularly. See gun manual.
- Use compressed air to prevent dust buildup on control boards, fan, and motor (under shield).

Fluid Inlet Strainer Screen

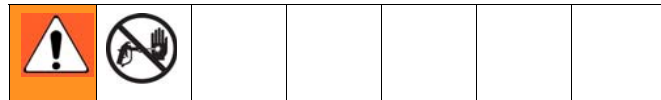

The inlet strainers filter out particles that can plug the pump inlet check valves. Inspect the screens daily as part of the startup routine, and clean as required.

Use clean chemicals and follow proper storage, transfer, and operating procedures, to minimize contamination of the A-side screen.

 Clean the A-side screen only during daily startup. This minimizes moisture contamination by immediately flushing out any isocyanate residue at the start of dispensing operations.

1. Close the fluid inlet valve at the pump inlet and shut off the appropriate feed pump. This prevents material from being pumped while cleaning the screen.
2. Place a container under the strainer manifold (59d) to catch fluid. Remove the strainer plug (59j).
3. Remove the screen (59g) from the strainer manifold. Thoroughly flush the screen with compatible solvent and shake it dry. Inspect the screen. If more than 25% of the mesh is blocked, replace the screen. Inspect the gasket (59h) and replace as required.
4. Ensure the pipe plug (59k) is screwed into the strainer plug (59j). Install the strainer plug with the screen (59g) and gasket (59h) in place and tighten. Do not overtighten. Let the gasket make the seal.
5. Open the fluid inlet valve, ensure that there are no leaks, and wipe the equipment clean. Proceed with operation.

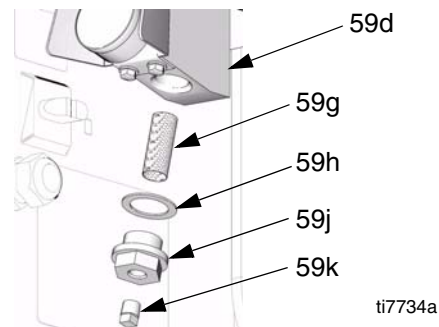

FIG. 8. Fluid Inlet Strainer

Pump Lubrication System



Check the condition of the ISO pump lubricant daily. Change the lubricant if it becomes a gel, its color darkens, or it becomes diluted with isocyanate.

Gel formation is due to moisture absorption by the pump lubricant. The interval between changes depends on the environment in which the equipment is operating. The pump lubrication system minimizes exposure to moisture, but some contamination is still possible.

Lubricant discoloration is due to continual seepage of small amounts of isocyanate past the pump packings during operation. If the packings are operating properly, lubricant replacement due to discoloration should not be necessary more often than every 3 or 4 weeks.

To change pump lubricant:

1. Relieve pressure, page 29.
2. Lift the lubricant reservoir (LR) out of the bracket (RB) and remove the container from the cap. Holding the cap over a suitable container, remove the check valve and allow the lubricant to drain. Reattach the check valve to the inlet hose. See FIG. 9.
3. Drain the reservoir and flush it with clean lubricant.
4. When the reservoir is flushed clean, fill with fresh lubricant.
5. Thread the reservoir onto the cap assembly and place it in the bracket.
6. Push the larger diameter supply tube (ST) approximately 1/3 of the way into the reservoir.
7. Push the smaller diameter return tube (RT) into the reservoir until it reaches the bottom.

Important: The return tube (RT) must reach the bottom of the reservoir, to ensure that isocyanate crystals will settle to the bottom and not be siphoned into the supply tube (ST) and returned to the pump.

8. The lubrication system is ready for operation. No priming is required.

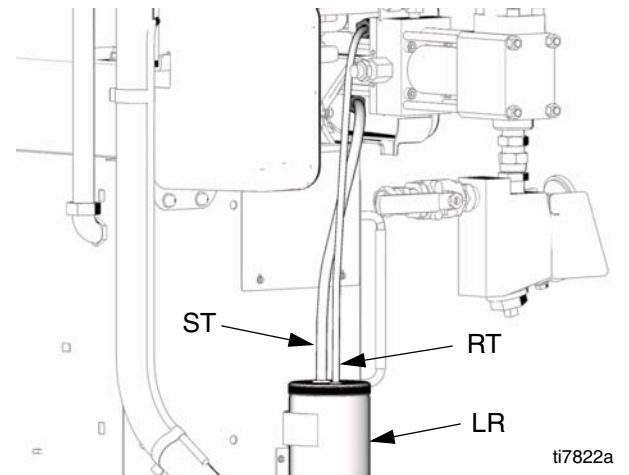
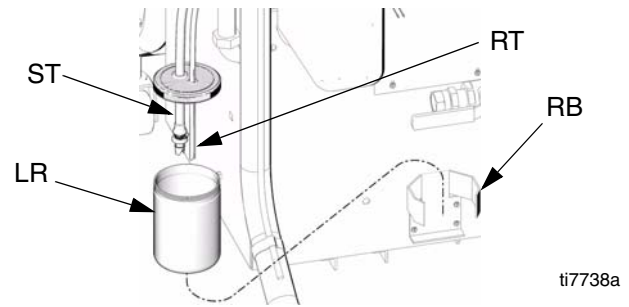



FIG. 9. Pump Lubrication System

Flushing

						
Flush equipment only in a well-ventilated area. Do not spray flammable fluids. Do not turn on heaters while flushing with flammable solvents.						

- Flush out old fluid with new fluid, or flush out old fluid with a compatible solvent before introducing new fluid.
- Use the lowest possible pressure when flushing.
- All fluid components are compatible with common solvents. Use only moisture-free solvents.

- To flush feed hoses, pumps, and heaters separately from heated hoses, set PRESSURE RELIEF/SPRAY valves (SA, SB) to PRESSURE RELIEF. Flush through bleed lines (N).

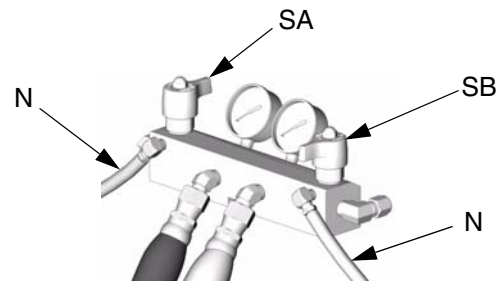

ti2481a

- To flush entire system, circulate through gun fluid manifold (with manifold removed from gun).
- To prevent moisture from reacting with isocyanate, always leave the system dry or filled with a moisture-free plasticizer or oil. Do not use water. See page 7.

Dimensions

Dimension	in. (mm)	Dimension	in. (mm)
A (height)	55.0 (1397)	F (side mounting holes)	16.25 (413)
B (width)	39.6 (1006)	G (mounting post inner diameter)	0.44 (11)
C (depth)	18.5 (470)	H (front mounting post height)	2.0 (51)
D (front mounting holes)	29.34 (745)	J (rear mounting post height)	3.6 (92)
E (rear mounting holes)	33.6 (853)		

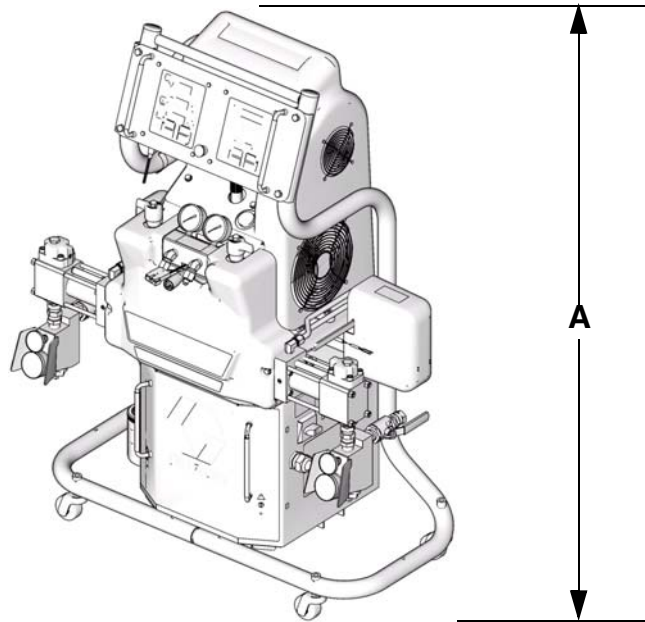

ti7705a

Top View

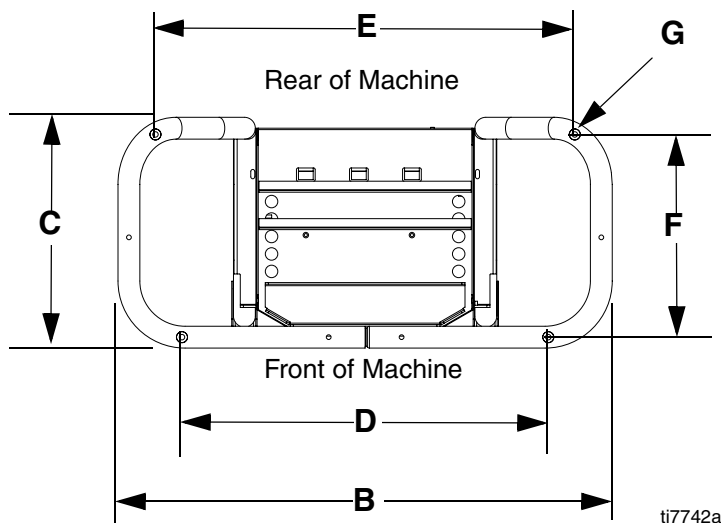

ti7742a

Side View

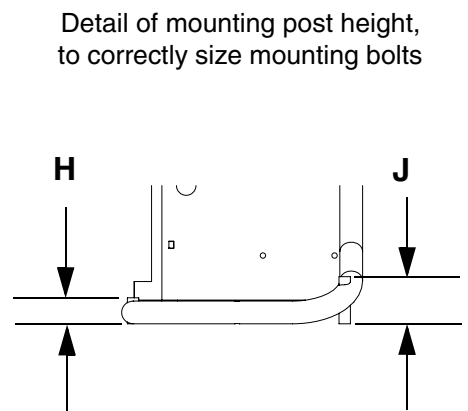

ti7743a

Technical Data

Category	Data
Maximum Fluid Working Pressure	Model H-25: 2000 psi (13.8 MPa, 138 bar) Model H-XP2: 3500 psi (24.1 MPa, 241 bar)
Fluid:Oil Pressure Ratio	Model H-25: 1.91:1 Model H-XP2: 2.79:1
Fluid Inlets	Component A (ISO): 3/4 npt(f), 250 psi (1.75 MPa, 17.5 bar) maximum Component B (RES): 1/2 npt(f), 250 psi (1.75 MPa, 17.5 bar) maximum
Fluid Outlets	Component A (ISO): #8 JIC (3/4-16 unf), with #5 JIC adapter Component B (RES): #10 JIC (7/8-14 unf), with #6 JIC adapter
Fluid Circulation Ports	1/4 npsm(m), with plastic tubing, 250 psi (1.75 MPa, 17.5 bar) maximum
Maximum Fluid Temperature	190°F (88°C)
Maximum Output (10 weight oil at ambient temperature)	Model H-25: 22 lb/min (10 kg/min) at 35 cycles/min (60 Hz) Model H-XP2: 1.5 gpm (5.7 liter/min) at 35 cycles/min (60 Hz)
Output per Cycle (A and B)	Model H-25: 0.063 gal. (0.23 liter) Model H-XP2: 0.042 gal. (0.16 liter)
Line Voltage Requirement	230V 1 phase and 230V 3 phase units: 195-264 Vac, 50/60 Hz 380V 3 phase units: 338-457 Vac, 50/60 Hz
Amperage Requirement	See tables, page 3.
Heater Power (A and B heaters total, no hose)	See tables, page 3.
Hydraulic reservoir capacity	1.2 gal. (4.5 liters)
Recommended hydraulic fluid	Citgo A/W Hydraulic Oil, ISO Grade 46
Sound power, per ISO 9614-2	87.8 dB(A)
Sound pressure, 1 m from equipment	80.2 dB(A)
Weight	Units with 8 kW Heaters: 498 lb (226 kg) Units with 15.3 kW Heaters: 525 lb (238 kg)
Wetted Parts	Aluminum, stainless steel, zinc-plated carbon steel, brass, carbide, chrome, fluoroelastomer, PTFE, ultra-high molecular weight polyethylene, chemically resistant o-rings

All other brand names or marks are used for identification purposes and are trademarks of their respective owners.

Graco Standard Warranty

Graco warrants all equipment referenced in this document which is manufactured by Graco and bearing its name to be free from defects in material and workmanship on the date of sale to the original purchaser for use. With the exception of any special, extended, or limited warranty published by Graco, Graco will, for a period of twelve months from the date of sale, repair or replace any part of the equipment determined by Graco to be defective. This warranty applies only when the equipment is installed, operated and maintained in accordance with Graco's written recommendations.

This warranty does not cover, and Graco shall not be liable for general wear and tear, or any malfunction, damage or wear caused by faulty installation, misapplication, abrasion, corrosion, inadequate or improper maintenance, negligence, accident, tampering, or substitution of non-Graco component parts. Nor shall Graco be liable for malfunction, damage or wear caused by the incompatibility of Graco equipment with structures, accessories, equipment or materials not supplied by Graco, or the improper design, manufacture, installation, operation or maintenance of structures, accessories, equipment or materials not supplied by Graco.

This warranty is conditioned upon the prepaid return of the equipment claimed to be defective to an authorized Graco distributor for verification of the claimed defect. If the claimed defect is verified, Graco will repair or replace free of charge any defective parts. The equipment will be returned to the original purchaser transportation prepaid. If inspection of the equipment does not disclose any defect in material or workmanship, repairs will be made at a reasonable charge, which charges may include the costs of parts, labor, and transportation.

THIS WARRANTY IS EXCLUSIVE, AND IS IN LIEU OF ANY OTHER WARRANTIES, EXPRESS OR IMPLIED, INCLUDING BUT NOT LIMITED TO WARRANTY OF MERCHANTABILITY OR WARRANTY OF FITNESS FOR A PARTICULAR PURPOSE.

Graco's sole obligation and buyer's sole remedy for any breach of warranty shall be as set forth above. The buyer agrees that no other remedy (including, but not limited to, incidental or consequential damages for lost profits, lost sales, injury to person or property, or any other incidental or consequential loss) shall be available. Any action for breach of warranty must be brought within two (2) years of the date of sale.

GRACO MAKES NO WARRANTY, AND DISCLAIMS ALL IMPLIED WARRANTIES OF MERCHANTABILITY AND FITNESS FOR A PARTICULAR PURPOSE, IN CONNECTION WITH ACCESSORIES, EQUIPMENT, MATERIALS OR COMPONENTS SOLD BUT NOT MANUFACTURED BY GRACO. These items sold, but not manufactured by Graco (such as electric motors, switches, hose, etc.), are subject to the warranty, if any, of their manufacturer. Graco will provide purchaser with reasonable assistance in making any claim for breach of these warranties.

In no event will Graco be liable for indirect, incidental, special or consequential damages resulting from Graco supplying equipment hereunder, or the furnishing, performance, or use of any products or other goods sold hereto, whether due to a breach of contract, breach of warranty, the negligence of Graco, or otherwise.

FOR GRACO CANADA CUSTOMERS

The Parties acknowledge that they have required that the present document, as well as all documents, notices and legal proceedings entered into, given or instituted pursuant hereto or relating directly or indirectly hereto, be drawn up in English. Les parties reconnaissent avoir convenu que la rédaction du présente document sera en Anglais, ainsi que tous documents, avis et procédures judiciaires exécutés, donnés ou intentés, à la suite de ou en rapport, directement ou indirectement, avec les procédures concernées.

Graco Information

TO PLACE AN ORDER, contact your Graco distributor or call to identify the nearest distributor.

Phone: 612-623-6921 **or Toll Free:** 1-800-328-0211 **Fax:** 612-378-3505

*All written and visual data contained in this document reflects the latest product information available at the time of publication.
Graco reserves the right to make changes at any time without notice.*

This manual contains English. MM 311299

Graco Headquarters: Minneapolis

International Offices: Belgium, China, Japan, Korea

GRACO INC. P.O. BOX 1441 MINNEAPOLIS, MN 55440-1441

www.graco.com

4/2006, Revised 9/2007